



Huntington 3 Series

# HTG-3P

SUSPENDED

Brilliant by Design™, minimalistic aesthetic combined with our innovative Microstructure EdgeTech Optics (MEO)™ will bring your vision to light. The innovative MEO™ design utilizes high efficiency Microstructure Lenses and Light Guide Plates for high optical extraction and precise light management.

## FEATURES

- Innovative Microstructure EdgeTech Optics™ delivers unparalleled optic control and exceptional performance with seamless illumination and uniformity. Specify Batwing, Glare Control, Diffused (Lambertian), Wall Wash or Ceiling Wash optics.
- MEO™ allows for minimalistic 3" Aperture fixtures with extremely low profile Depths: 1.38" Remote Driver - 3.40" Integral Driver.
- 3.4" x 3.4" square profile (integral driver) was designed to match the HTGDU-3P profile for a consistent architectural look within the space.
- Individual fixture lengths and seamless continuous rows with no lens breaks, pixelation or hotspots up to 300 feet.
- Innovative Toolless "Push to Eject" system allows for easy installation and serviceability.
- Aircraft Cable or 361° locking Aircraft Cable Rotational mounting.
- Integral Driver, Remote Driver, In-Canopy Driver and In-Canopy Emergency Driver options.
- No visible fasteners.
- Custom powder coat and anodized finishes.
- Specified Lumen Outputs (SLO) available.
- Proudly crafted in Huntington Beach, CA - USA.

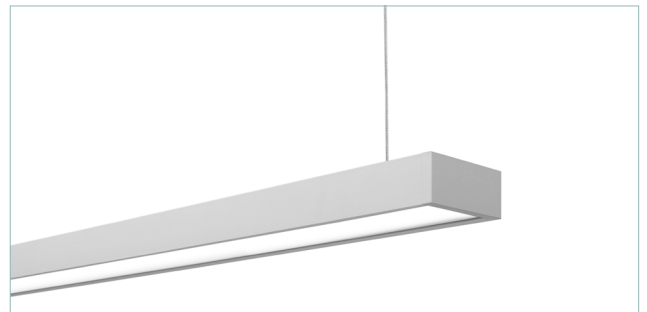

SUSPENDED

## Performance Overview

| 4' Huntington 3 Direct - 3500K 90CRI MEODF |          |             |           |                  |
|--|----------|-------------|-----------|------------------|
| Lumen Output                               | LL (Low) | ML (Medium) | HL (High) | SLO* (Specified) |
| Delivered Lumens                           | 896      | 2208        | 4352      | 896-6852         |
| Consumed Wattage                           | 7        | 18          | 38        | 7.3 - 65.6       |
| Efficacy (lm/W)                            | 122      | 121         | 115       | 105-122          |
| SDCM                                       | 3        | 3           | 3         | 3                |

\*Specified Lumen Output (SLO) available in customizable lumen configurations (896 lm - 6852 lm). See SLO Configurator [HERE](#)



**ORDERING INFORMATION**

EXAMPLE: HTG-3P-TD-DT-24-DLL-27-MEODF-VU-D-SA-EMC2-24-C5-SQS

Project: \_\_\_\_\_

Date: \_\_\_\_\_ Type: \_\_\_\_\_

| Product Family   | Driver Location                                      | Mounting Direction                     | Length  | Lumen Output  | Color Temp  |
|--|--|--|---|---|---|
| <b>HTG-3P</b><br>HTG-3P Huntington Series 3" Aperture (Suspended)            | <b>TD</b> Integral Driver<br><b>RD</b> Remote Driver | <b>DT</b> Direct<br><b>UT</b> Indirect | ____* Specify length in 1 foot increments<br><b>R_X_</b> Rectangle<br><b>L_X_</b> L Pattern<br><b>U_X_X_</b> U Pattern<br><b>PC</b> Custom Pattern  | <b>DLL</b> Low (224 l/ft @ 1.84 W)*<br><b>DML</b> Medium (552 l/ft @ 4.55 W)*<br><b>DHL</b> High (1088 l/ft @ 9.46 W)*<br><b>SLO-XX</b> Specified Lumen Output available.**                               | <b>27</b> 2700K<br><b>30</b> 3000K<br><b>35</b> 3500K<br><b>40</b> 4000K<br><b>50</b> 5000K<br><b>TW</b> 2700K-6500K (85+ CRI)<br><b>XX</b> Optional Color Temp & CRI Available                           |
| In Canopy remote drivers available. Consult factory for spec code & details. |  |  | *Minimum Integral Driver length is 2'. Minimum Remote or In Canopy Driver can be shorter, consult factory.<br>*Custom length fixtures can be ordered in 3" increments.<br>*Any length over 8' requires multiple fixture segments. | *Delivered lumen output & consumed wattage based on "MEODF 35" (90 CRI - 3500K). See SLO Configurator for alternate outputs.<br>**See SLO Configurator at ExtantLighting.com for appropriate "XX" output. | *Delivered lumen output & consumed wattage based on "MEODF 35" (90 CRI - 3500K). See SLO Configurator for alternate outputs.<br>**See SLO Configurator at ExtantLighting.com for appropriate "xx" output. |

| Optics  | Voltage                               | Driver  | Finish   | Options   |
|---|---------------------------------------|---|--|---|
| <b>MEO</b><br><b>MEODF</b> Diffusing<br><b>MEOBW</b> Batwing<br><b>MEOGC</b> Glare Control<br><b>MEORF</b> Room Fill*<br><b>MEOWW</b> Wall Wash*<br><b>MEOCW</b> Ceiling Wash**<br><b>PRO***</b><br><b>PROAY</b> Asymmetric<br><b>PROWD</b> Wide<br><b>PRONR</b> Narrow | <b>VU</b> 120V-277V<br><b>V3</b> 347V | <b>D*</b> 1% 0-10V<br><b>DN</b> NON DIM<br><b>DELV</b> 1% Electronic Low Voltage Dimming (Reverse Phase dimming)<br><b>DTRIAC</b> 1% Electronic Low Voltage Dimming (Forward Phase dimming)<br><b>DL1</b> Lutron Hi-Lume 1% EcoSystem<br><b>DE</b> .1% 0-10V<br><b>DD1</b> 1% DALI<br><b>DDE</b> .1% DALI<br><b>DMX</b> .1% DMX/RDM<br><b>DTW</b> .1% 0-10V Tunable White<br><b>DDTW</b> .1% DALI Tunable White<br><b>XX</b> Other (Please Specify) | <b>SA*</b> Silver Anodized<br><b>WP*</b> Matte White<br><b>BP*</b> Matte Black<br><b>CC**</b> Custom<br><b>SAMF</b> SA Housing/Machine Finish End Caps<br><b>WPMF</b> WP Housing/Machine Finish End Caps<br><b>BPMF</b> BP Housing/Machine Finish End Caps<br><b>CCMF</b> CC Housing/Machine Finish End Caps | <b>EMC_*</b> Emergency Circuit(s)<br><b>EMB_*</b> Emergency Battery Pack(s)<br><b>SOC*</b> Occupancy Sensor<br><b>SDL*</b> Daylight Sensor<br><b>MTC*</b> Multiple Circuit(s) (Daylight, Occupancy, Zone Specific)<br><b>BCS*</b> Brilliant Communications Solutions (wired/wireless)<br><b>2C</b> 2 Circuit (Direct Light and Indirect Light (Controlled Independently))<br><b>JAB</b> JAB Compliant |
| *Indirect Only<br>**MEOCW not configurable when MEORF selected<br>***PRO Optics are not a diffused light source. LED pixelation will be seen with this optic choice.  |                                       | *Dim to Off available. Please Specify "-OFF" next to driver option if required.   | *The housing finish and end cap finish will match.<br>** Custom Color (CC) to be provided in satin finish and color to be specified by a RAL number. The housing finish and end cap finish will match.   | *EMC: Specify quantity of emergency circuits.<br>*EMB: Specify quantity of battery packs. Minimum 4' unit.<br>*SOC & SDL: Specify spacing/location of sensor(s).<br>*MTC: Circuit location(s) to be identified through factory supplied drawings<br>*BCS: includes wired and wireless integration from our partners at rLight™, enlightened, Legrand, Crestron, Osram, Lutron and many more.          |

| Mounting   | Cable Length  | Power Cord   | Canopy Mounting   | Canopy Shape/Finish   |
|--|---|--|---|---|
| <b>AC</b> Aircraft Cable<br><b>AR</b> Rotational (1" Rotational Hub) | <b>24</b> 24"<br><b>48</b> 48"<br><b>72</b> 72"<br><b>96</b> 96"<br><b>144</b> 144"<br>____* Custom Length (Please Specify) | <b>SL</b> Silver<br><b>WH</b> White<br><b>BK</b> Black | <b>REMOTE DRIVER OPTIONS</b><br><b>C5</b> 5" Canopies - JBox (Standard)<br><b>NC</b> No Canopies at all Cables<br><b>C2</b> 2" Canopies at all Cables - Structure Mounting<br><b>9T5*</b> 9/16 Grid Mounted 5" Canopies at all cables<br><b>1T5*</b> 15/16 Grid Mounted 5" Canopies at all cables<br><b>ABT5*</b> Armstrong Interlude or Bolt Slot Grid Mounted 5" Canopies at all cables | <b>INTEGRAL DRIVER OPTIONS</b><br><b>C5</b> 5" Canopies - JBox (Standard)<br><b>NC</b> No Canopies at all Cables Except 5" at Power Feed<br><b>C2</b> 2" Canopies at all Cables - Structure Mounting<br><b>C25</b> 5" Canopies at Power Feed(s) - 2" Canopies at Cables<br><b>9T5*</b> 9/16 Grid Mounted - 5" Canopies at all cables<br><b>1T5*</b> 15/16 Grid Mounted - 5" Canopies at all cables<br><b>ABT5*</b> Armstrong Interlude/Bolt Slot Grid Mounted - 5" Canopies at all cables<br><b>9T25*</b> 9/16 Grid Mounted - 5" Canopies at Power Feed(s) - 2" Canopies at Cables<br><b>1T25*</b> 5/16 Grid Mounted - 5" Canopies at Power Feed(s) - 2" Canopies at Cables<br><b>ABT25*</b> Armstrong Interlude or Bolt Slot Grid Mounted 5" Canopies at Power Feed(s) - 2" Canopies at Cables |
| *Finish of Rotational Hub will match end cap finish                  |   |  | *Fixture mounting to be installed in line with Main Beams or Cross Tee's. Not designed to be mounted across Main Beams or Cross Tee's   | <b>SQS</b> Square Silver<br><b>SQW</b> Square Matte White<br><b>SQB</b> Square Matte Black<br><b>RNS</b> Round Silver<br><b>RNW</b> Round Matte White<br><b>RNB</b> Round Matte Black   |



## Specifications

**CONSTRUCTION** One-piece heavy gauge 6063 extruded aluminum housing. Precision-machined aluminum end caps.

**OPTICS** Microstructure EdgeTech Optics (MEO)™ utilizes high efficiency Microstructure Lenses and Light Guide Plates for high optical extraction and precise light management. Specify Batwing, Glare Control, Diffused (Lambertian), Wall Wash, Room Fill or Ceiling Wash Optics.

**LIGHT OUTPUT** (3) Standard lumen packages are available: Low (DLL), Medium (DML) and High (DHL). Specified Lumen Output (SLO) packages available. Please see the (SLO) configurator at [ExtantLighting.com](http://ExtantLighting.com).

**LEDS** Latest generation of premium Nichia 3-step MacAdam Ellipse LED's available in (90+ CRI) 2700K, 3000K, 3500K, 4000K. LED modules are easily accessible and replaceable.

**VOLTAGE** Universal 120/277V (VU) and 347V (V3) available. Consult factory for driver options when 347V is specified.

**BATTERY BACKUP** Factory provided low profile 10W battery for UL924 required 90-minute run time (optional).

**FINISH** Standard finishes include silver anodized, powder coated white or powder coated black. Custom anodized and powder coated finishes available (RAL number matched). Power cord and canopy finishes are white, black or silver.

**CONTINUOUS ROWS** Innovative Toolless Latch System ensures simple installation. Seamless continuous rows with no lens breaks, pixelation or hotspots up to 300 feet with MEODF or 250 feet with MEOGC.

**PATTERNS** Standard Rectangle Pattern (R), U Pattern (U), and L Pattern (L) available.

**MOUNTING** Remote Driver Fixtures: Adjustable 3/64" Aircraft Cable or 361° locking 3/64" Aircraft Cable Rotational with precision-machined 1" rotational hub. Integral Driver Fixtures: Adjustable 1/16" Aircraft Cable and 1/16" Aircraft Cable Rotational with precision-machined 1" rotational hub.

**APPROVALS** UL and cUL Listed. Approved for Dry/Damp locations. Made in the USA. JA8 Compliant.

**LUMEN** Maintenance (L70) 70% of initial light output = Reported > 60,000 hours | Calculated > 200,000 hours (L90) 90% of initial light output = Reported > 60,000 hours | Calculated > 200,000 hours.

**WARRANTY** HTG 3 offered with a 5-year limited warranty. 5-year limited warranty covers LED, driver and fixture. For further details, refer to General Warranty and Obligations at [ExtantLighting.com](http://ExtantLighting.com).

**PATENTS** Extant Lighting's intellectual property is protected under Patent No. US 11,378,262 B2 by the U.S. Patent Office.

## Dimensions

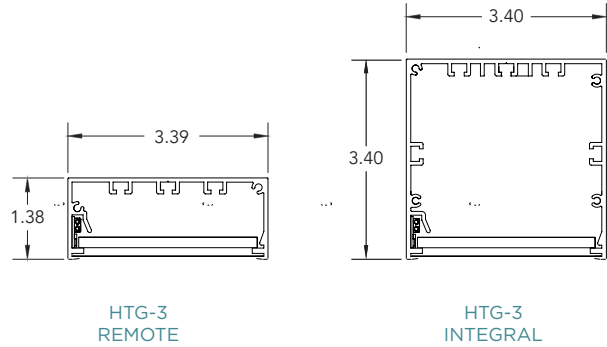

## Patterns

Note: All miters/patterns shown and ordered in plan view.

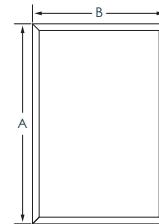

R\_X\_  
Rectangle  
Provide AxB  
Example: R6'x4'

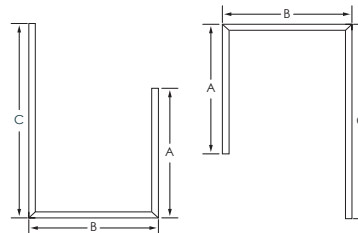

U\_X\_X\_  
U-Shape  
Provide AxBxC  
Example: B U6'x4'x4'

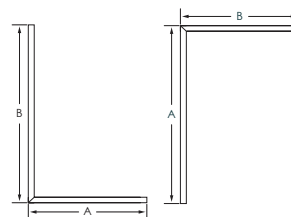

L\_X\_  
L-Shape  
Provide AxB  
Example: L6'x4'



**Microstructure EdgeTech Optics (MEO)™**

Our innovative MEO™ design utilizes high efficiency Microstructure Lenses and Light Guide Plates for high optical extraction and precise light management. MEO™ delivers exceptional light quality with seamless illumination and uniformity with no pixelation, hot spots or lens breaks up to 300' continuous rows.

**DIRECT**

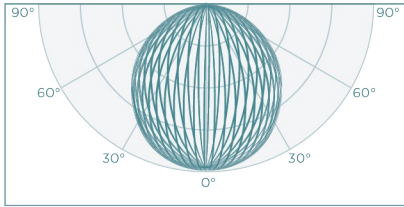

**MEODF**  
LAMBERTIAN

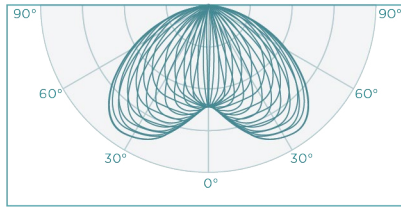

**MEOBW**  
BATWING

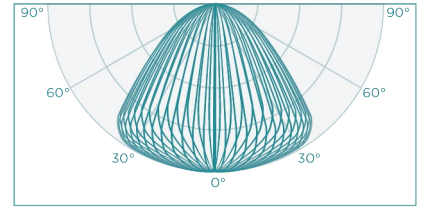

**MEOGC**  
GLARE CONTROL

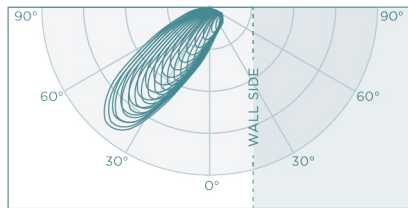

**MEORF**  
ROOM FILL

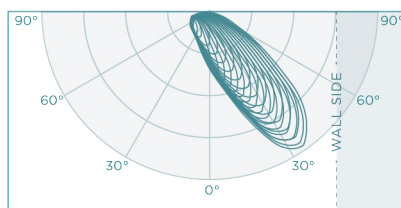

**MEOWW**  
WALL WASH

**INDIRECT**

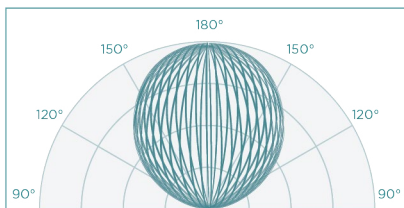

**MEODF**  
LAMBERTIAN

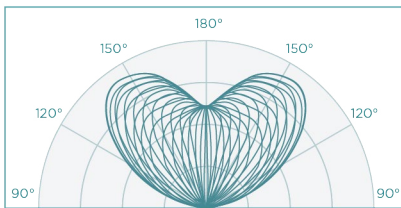

**MEOBW**  
BATWING

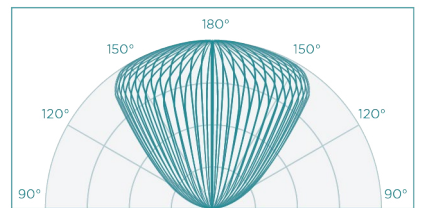

**MEOGC**  
GLARE CONTROL

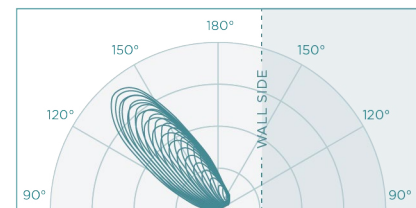

**MEOCW**  
CEILING WASH



### Precision Refractive Optics (PRO)

Precision Refractive Optics (PRO) are designed to produce precise optic control for diverse design applications. PRO Optics are only available in indirect orientation. PRO utilizes the latest in extruded lens technology that mount directly to the LED board channel to give optimum control.

Please Note: The PRO optics are not a diffused light source. LED pixelation will be seen with this optic choice. If you want a completely diffused light source with no pixelation or hot spots, see our Microstructure EdgeTech Optics (MEO)™ options.

#### INDIRECT

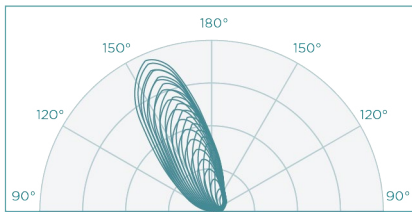

**PROAY**  
ASYMMETRIC

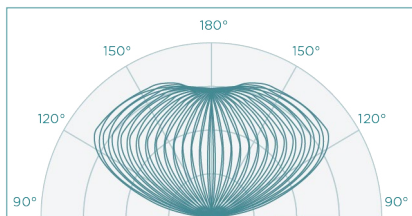

**PROWD**  
WIDE

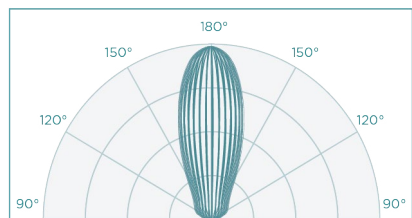

**PRONR**  
NARROW

### Continuous Row Detail

*NOTE: Detail below is specific to the Aircraft Cable (AC) with Integral Driver (TD) only. For additional Continuous Row Detail, please visit [ExtantLighting.com](http://ExtantLighting.com)*

| Nominal Row Length (ft) | Segment Lengths (ft)  | Overall Row Length |
|-------------------------|-----------------------|--------------------|
| 9                       | 5 + 4                 | 9' 1/2"            |
| 10                      | 6 + 4                 | 10' 1/2"           |
| 11                      | 7 + 4                 | 11' 1/2"           |
| 12                      | 8 + 4                 | 12' 1/2"           |
| 13                      | 8 + 5                 | 13' 1/2"           |
| 14                      | 8 + 6                 | 14' 1/2"           |
| 15                      | 8 + 7                 | 15' 1/2"           |
| 16                      | 8 + 8                 | 16' 1/2"           |
| 17                      | 8 + 5 + 4             | 17' 1/2"           |
| 18                      | 8 + 6 + 4             | 18' 1/2"           |
| 19                      | 8 + 7 + 4             | 19' 1/2"           |
| 20                      | 8 + 8 + 4             | 20' 1/2"           |
| 21                      | 8 + 8 + 5             | 21' 1/2"           |
| 22                      | 8 + 8 + 6             | 22' 1/2"           |
| 23                      | 8 + 8 + 7             | 23' 1/2"           |
| 24                      | 8 + 8 + 8             | 24' 1/2"           |
| 25                      | 8 + 8 + 5 + 4         | 25' 1/2"           |
| 26                      | 8 + 8 + 6 + 4         | 26' 1/2"           |
| 27                      | 8 + 8 + 7 + 4         | 27' 1/2"           |
| 28                      | 8 + 8 + 8 + 4         | 28' 1/2"           |
| 29                      | 8 + 8 + 8 + 5         | 29' 1/2"           |
| 30                      | 8 + 8 + 8 + 6         | 30' 1/2"           |
| 31                      | 8 + 8 + 8 + 7         | 31' 1/2"           |
| 32                      | 8 + 8 + 8 + 8         | 32' 1/2"           |
| 33                      | 8 + 8 + 8 + 5 + 4     | 33' 1/2"           |
| 34                      | 8 + 8 + 8 + 6 + 4     | 34' 1/2"           |
| 35                      | 8 + 8 + 8 + 7 + 4     | 35' 1/2"           |
| 36                      | 8 + 8 + 8 + 8 + 4     | 36' 1/2"           |
| 37                      | 8 + 8 + 8 + 8 + 5     | 37' 1/2"           |
| 38                      | 8 + 8 + 8 + 8 + 6     | 38' 1/2"           |
| 39                      | 8 + 8 + 8 + 8 + 7     | 39' 1/2"           |
| 40                      | 8 + 8 + 8 + 8 + 8     | 40' 1/2"           |
| 41                      | 8 + 8 + 8 + 8 + 5 + 4 | 41' 1/2"           |
| 42                      | 8 + 8 + 8 + 8 + 6 + 4 | 42' 1/2"           |
| 43                      | 8 + 8 + 8 + 8 + 7 + 4 | 43' 1/2"           |
| 44                      | 8 + 8 + 8 + 8 + 8 + 4 | 44' 1/2"           |
| 45                      | 8 + 8 + 8 + 8 + 8 + 5 | 45' 1/2"           |
| 46                      | 8 + 8 + 8 + 8 + 8 + 6 | 46' 1/2"           |
| 47                      | 8 + 8 + 8 + 8 + 8 + 7 | 47' 1/2"           |
| 48                      | 8 + 8 + 8 + 8 + 8 + 8 | 48' 1/2"           |



**Installation**

Thoughtful engineering is at the core of all of our fixture designs. All of our products are thoughtfully engineered and include innovative features that create a sophisticated fixture that is also contractor friendly and easy to install and service.

**PUSH TO EJECT SYSTEM**

Innovative “Push to Eject” System allows for toolless removal and installation of the Light Guide Plate. This thoughtful engineering creates easy access into the housing for simple installation and serviceability.

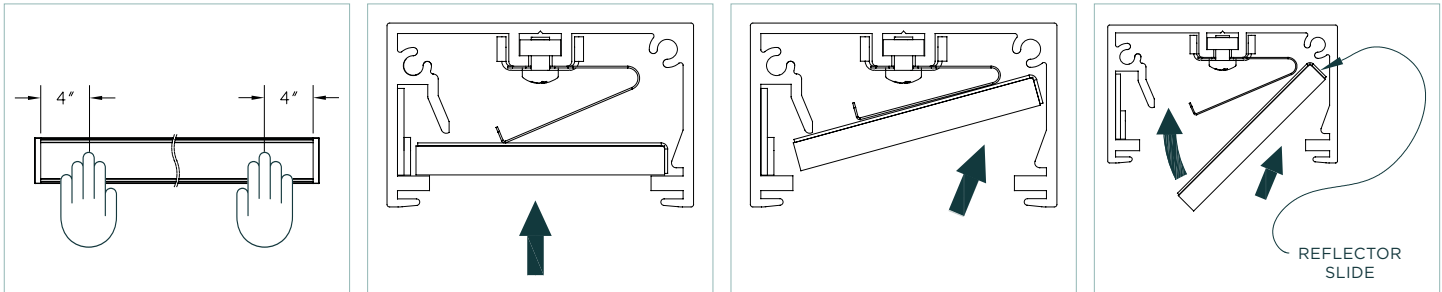

**TOOLLESS LATCH SYSTEM**

Our Toolless Latch System is designed to securely connect the extrusions of the continuous runs without the use of any tools, screws or external parts. Our innovative design allows the contractor to perfectly align the extrusion with the built-in alignment pins and cinch up the extrusion with the Toolless Latch System for a tight fit. The Toolless Latch System eliminates gaps and ensures perfect alignment.

**QUICK-CLICK 5-WIRE SYSTEM**

Our Quick-Click 5-Wire System connects the continuous run through wiring with a simple push and click connection. The Quick-Click System is contractor friendly and decreases installation time and cost and ensures proper wiring.

