



Huntington 3 Series

HTG-3R-LP

RECESSED CEILING

Brilliant by Design™, the Huntington 3 Recessed LoPro is sure to level up your space. Our patent pending Microstructure EdgeTech Optics™ (MEO) technology delivers unparalleled optic control, low glare visual comfort, exceptional performance, seamless illumination, and uniformity in unprecedented low-profile behind ceiling depths. Lens gaps, pixelation and hot spots are a thing of the past with our innovative Dual Lens Edge-lit MEO™ technology.

FEATURES

- Low profile depth behind ceiling for use in any plenum installation:
 - 1.5" - 1.75" Depth (Remote Driver)
 - 2.14" - 2.45" Depth (Integral Driver)
- Design without compromise: Specify Batwing, Glare Control, Diffused (Lambertian) or Wall Wash Optics
- Specified Lumen Outputs (SLO) available: 224 lm/ft - 1754 lm/ft
- Sleek 3" Aperture
- Individual fixture lengths and seamless continuous runs with no lens breaks up to 300 feet
- Achieve up to 16 feet on center spacing with 35fc on work surface
- Drivers, wiring and serviceability completely accessible from below ceiling with our patented toolless "Push to Eject" System
- Toolless Latch System and Quick-Click 5 Wire system allows for simple, quick, and seamless installation
- Trim Flange, Spackle Flange, 15/16" or 9/16" Grid Lay-in 15/16" or 9/16" Grid Tegular, Bolt Slot or Armstrong Interlude/USG Identitec
- 4" TechZone™ compatible for seamless integration
- Proudly crafted in Huntington Beach, CA - USA

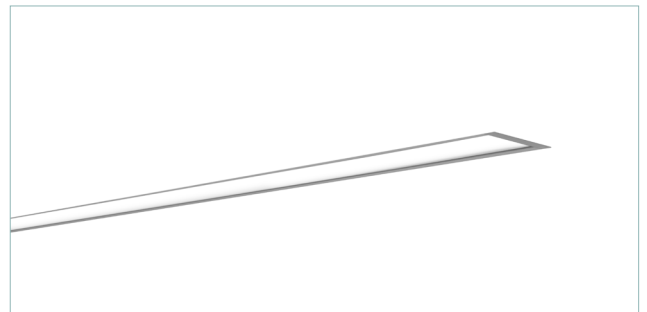

RECESSED

Performance Overview

4' Huntington 3 Direct - 3500K 90CRI MEODF				
Lumen Output	LL (Low)	ML (Medium)	HL (High)	SLO* (Specified)
Delivered Lumens	896	2208	4352	896-6852
Consumed Wattage	7	18	38	7.3 - 65.6
Efficacy (lm/W)	122	121	115	105-122
SDCM	3	3	3	3

*Specified Lumen Output (SLO) available in customizable lumen configurations (896 lm - 6852 lm). See SLO Configurator [HERE](#)



ORDERING INFORMATION

PROJECT _____ TYPE _____
 PRODUCT _____ QTY _____

Product Family	Driver Location	Trim	Length
HTG-3R-LP Huntington Series 3" Aperture (Recessed - LoPro)	<input type="checkbox"/> TD Intergral Driver <input type="checkbox"/> RD Remote Driver	<p>TRIM FLANGE</p> <input type="checkbox"/> TFSA Trim Flange - Silver Anodized <input type="checkbox"/> TFWP Trim Flange - Matte White <input type="checkbox"/> TFBP Trim Flange - Matte Black <input type="checkbox"/> TFCC Trim Flange - Custom Color	<input type="checkbox"/> _____* Specify length in 1 foot increments <input type="checkbox"/> R X Rectangle <input type="checkbox"/> L X L Pattern <input type="checkbox"/> U X X U Pattern <input type="checkbox"/> C W Ceiling to Wall Transition Example: C14'W12' <input type="checkbox"/> CP Custom Pattern
		<p>TRIMLESS</p> <input type="checkbox"/> SF Spackle Flange (Mud-in)	
		<p>T-GRID</p> <input type="checkbox"/> L1* 15/16" Grid Lay-in <input type="checkbox"/> L9* 9/16" Grid Lay-in <input type="checkbox"/> T1* 15/16" Grid Tegular <input type="checkbox"/> T9* 9/16" Grid Tegular <input type="checkbox"/> SB* Bolt Slot Grid <input type="checkbox"/> AI* Armstrong Interlude/USG Identitee	
		<p>*White finish is standard on all T-Grid (Suspended Ceiling) trim options (L1, L9, T1, T9, SB and AI)</p>	<p>*Minimum Integral Driver length is 2'. Minimum Remote Driver lengths can be shorter, consult factory. Custom length fixtures can be ordered in 3" increments. Any length over 8' requires multiple fixture segments.</p>

Lumen Output	Optics	Color Temp	Voltage
<input type="checkbox"/> DLL Low (224 l/ft @ 1.84 W)* <input type="checkbox"/> DML Medium (552 l/ft @ 4.55 W)* <input type="checkbox"/> DHL High (1088 l/ft @ 9.46 W)* <input type="checkbox"/> SLO-XX *Specified Lumen Output available. *Delivered lumen output & consumed wattage based on "MEODF 35" (90 CRI - 3500K). See SLO Configurator for alternate outputs.	<p>MEO*</p> <input type="checkbox"/> MEODF Diffusing <input type="checkbox"/> MEOBW Batwing <input type="checkbox"/> MEOGC Glare Control <input type="checkbox"/> MEOWW Wall Wash <input type="checkbox"/> MEORF Room Fill * See Page 5 for Optic Detail	<p>90+ CRI</p> <input type="checkbox"/> 27 2700K <input type="checkbox"/> 30 3000K <input type="checkbox"/> 35 3500K <input type="checkbox"/> 40 4000K <input type="checkbox"/> 50 5000K <input type="checkbox"/> XX Optional Color Temp & CRI Available	<input type="checkbox"/> VU 120V-277V <input type="checkbox"/> V3 347V

Driver	Options
<input type="checkbox"/> D* 1% 0-10V <input type="checkbox"/> DN NON DIM <input type="checkbox"/> DL1 Lutron Hi-Lume 1% EcoSystem <input type="checkbox"/> DE* .1% 0-10V <input type="checkbox"/> DD1 1% DALI <input type="checkbox"/> DDE .1% DALI <input type="checkbox"/> DMX .1% DMX/RDM <input type="checkbox"/> DELV 1% Electronic Low Voltage Dimming (Reverse Phase) <input type="checkbox"/> DTRIAC 1% Electronic Low Voltage Dimming (Forward Phase) <input type="checkbox"/> XX Other (Please Specify) *Dim to Off available. Please Specify "-OFF" next to driver option if required.	<input type="checkbox"/> EMB_* Emergency Battery Pack(s) <input type="checkbox"/> EMC_* Emergency Circuit(s) <input type="checkbox"/> SOC * Occupancy Sensor <input type="checkbox"/> SDL* Daylight Sensor <input type="checkbox"/> 2C 2 Circuit (Direct Light and Indirect Light Controlled Independently) <input type="checkbox"/> BCS* Brilliant Communications Solutions (wired/wireless) <input type="checkbox"/> CP Chicago Plenum Approved <input type="checkbox"/> JAB JAB Compliant <p>EMB: Specify quantity of battery packs. Minimum 4' unit. Note: Remote Driver (RD) fixtures will have remote battery packs. EMC: Specify quantity of emergency circuits. SOC & SDL: Specify spacing/location of sensor(s). BCS: includes wired and wireless integration from our partners at nLight™, Enlighted, Legrand, Crestron, Osram, Lutron and many more. Contact Extant for details.</p>



Specifications

CONSTRUCTION Heavy gauge 6063 extruded aluminum housing.

OPTICS Microstructure EdgeTech Optics (MEO)™ utilizes high efficiency Microstructure Lenses and Light Guide Plates for high optical extraction and precise light management. Specify Batwing, Glare Control, Diffused (Lambertian) or Wall Wash Optics.

LIGHT OUTPUT (3) Standard lumen packages are available: Low (DLL), Medium (DML) and High (DHL). Specified Lumen Output (SLO) packages available. Please see the (SLO) configurator at ExtantLighting.com.

LEDS Latest generation of premium Nichia 3-step MacAdam Ellipse LED's available in (90+ CRI) 2700K, 3000K, 3500K, 4000K. LED modules are easily accessible and replaceable.

VOLTAGE Universal 120/277V (VU) and 347V (V3) available. Consult factory for driver options when 347V is specified.

EMERGENCY Battery Factory provided low profile 10W emergency battery for UL924 required 90-minute run time (optional).

FINISH Standard finishes include silver anodized, powder coated white or powder coated black. White powder coat finish standard on all T-Grid trim options. Custom colors available.

CONTINUOUS ROWS Innovative Toolless Latch System and Quick-Click 5-Wire System ensures simple installation. Seamless continuous rows with no lens breaks, pixelation or hot spots up to 300 feet.

PATTERNS Standard Rectangle Pattern (R), U Pattern (U), and L Pattern (L) available. Custom patterns available.

MOUNTING Trim Flange, Spackle Flange, 15/16" or 9/16" Grid Lay-in, 15/16" or 9/16" Grid Tegular, Bolt Slot or Armstrong Interlude/USG Identitee.

APPROVALS UL and cUL Listed. Approved for Dry/Damp locations. IC Rated. Made in the USA. Chicago Plenum Approved. JA8 Approved.

LUMEN MAINTENANCE (L70) 70% of initial light output = Reported > 60,000 hours | Calculated > 200,000 hours (L90) 90% of initial light output = Reported > 60,000 hours | Calculated > 200,000 hours.

WARRANTY HTG 3 offered with a 5-year limited warranty. 5-year limited warranty covers LED, driver and fixture. For further details, refer to General Warranty and Obligations at ExtantLighting.com.

PATENTS Extant Lighting's intellectual property is protected under Patent No. US 11,378,262 B2 by the U.S. Patent Office.

Patterns

Note: All miters/patterns shown and ordered in plan view.

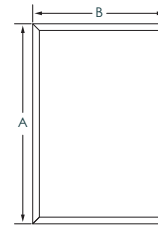

R__X__
Rectangle
Provide AxB
Example: R6'x4'

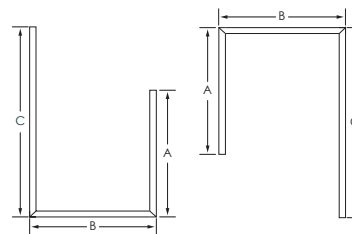

U__X__X__
U-Shape
Provide AxBxC
Example: B U6'x4'x4'

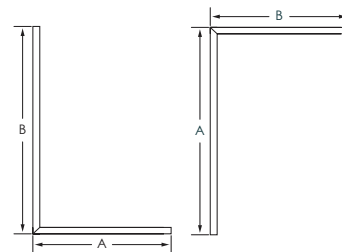

L__X__
L-Shape
Provide AxB
Example: L6'x4'

Dimensions

TF - TRIM FLANGE

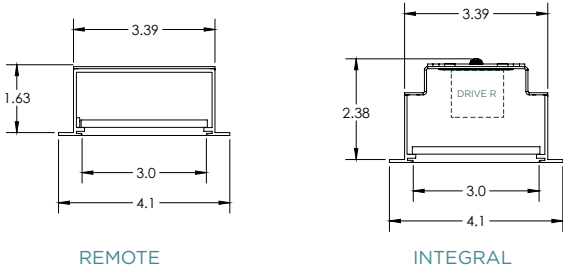

SF - SPACKLE FLANGE

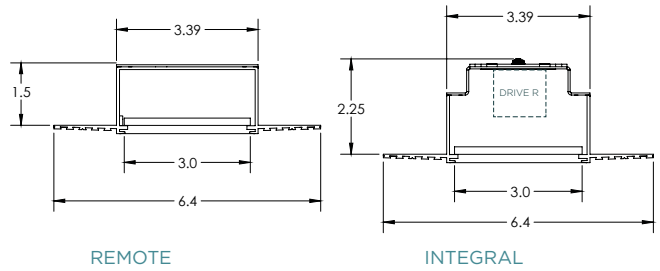

L1 - 15/16" Grid Lay-in

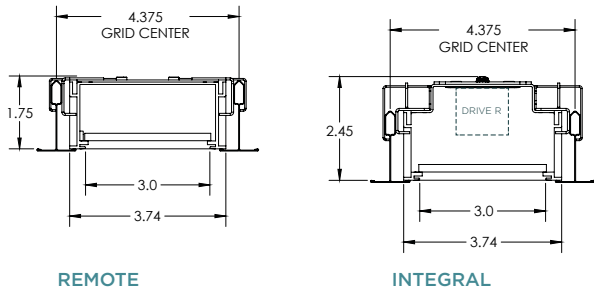

L9 - 9/16" GRID LAY-IN

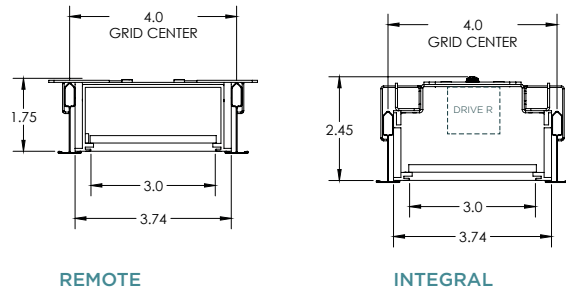

T1 - 15/16" Grid Tegular

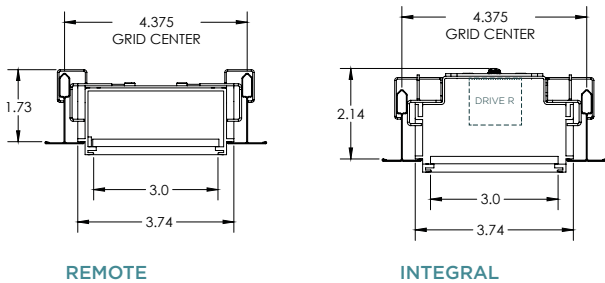

T9 - 9/16" Grid Tegular

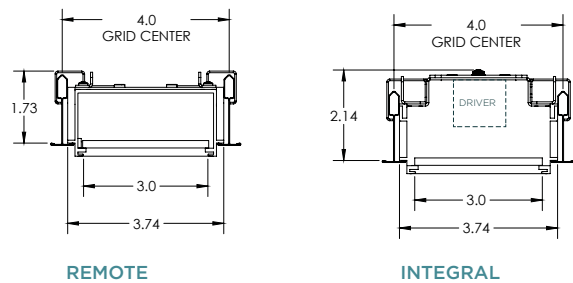

SB - Bolt Slot Grid

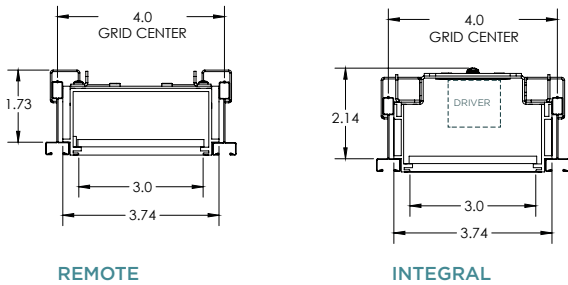

AI - Armstrong Interlude/ USG Identitee

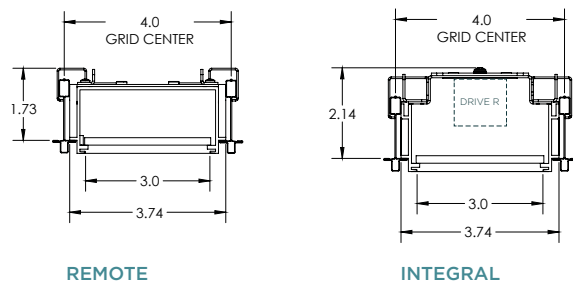

Microstructure EdgeTech Optics (MEO)™

Our innovative MEO™ design utilizes high efficiency Microstructure Lenses and Light Guide Plates for high optical extraction and precise light management. MEO™ delivers exceptional light quality with seamless illumination and uniformity with no pixelation, hot spots or lens breaks up to 300' continuous rows.

DIRECT

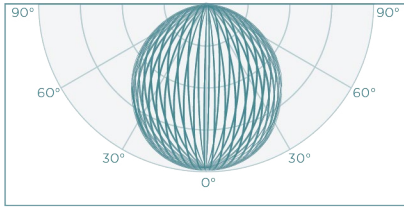

MEODF
LAMBERTIAN

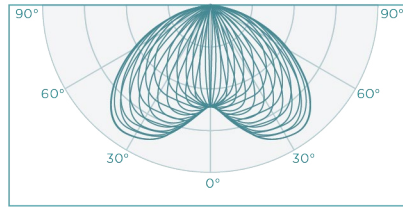

MEOBW
BATWING

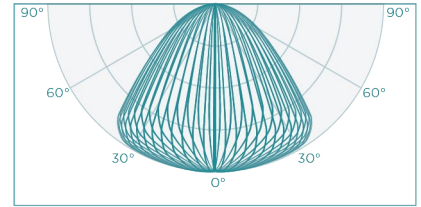

MEOGC
GLARE CONTROL

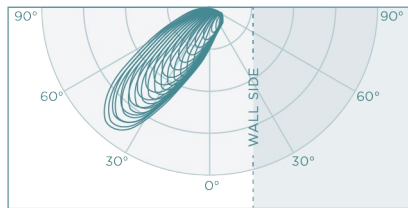

MEORF
ROOM FILL

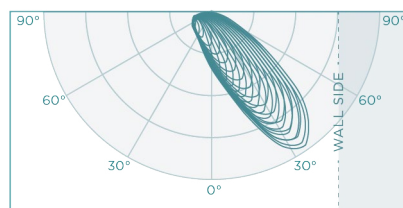

MEOWW
WALL WASH



Installation

Thoughtful engineering is at the core of all of our fixture designs. All of our products are thoughtfully engineered and include innovative features that create a sophisticated fixture that is also contractor friendly and easy to install and service.

PUSH TO EJECT SYSTEM

Innovative “Push to Eject” System allows for toolless removal and installation of the Light Guide Plate. This thoughtful engineering creates easy access into the housing for simple installation and serviceability.

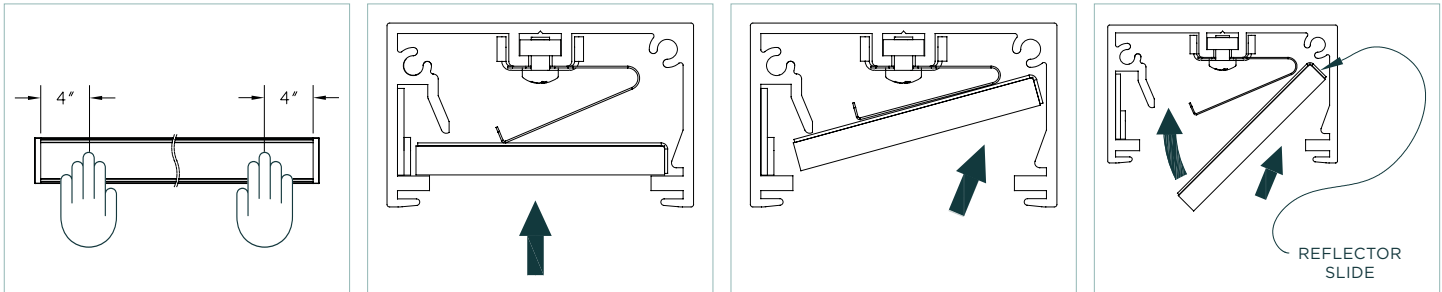

TOOLLESS LATCH SYSTEM

Our Toolless Latch System is designed to securely connect the extrusions of the continuous runs without the use of any tools, screws or external parts. Our innovative design allows the contractor to perfectly align the extrusion with the built-in alignment pins and cinch up the extrusion with the Toolless Latch System for a tight fit. The Toolless Latch System eliminates gaps and ensures perfect alignment.

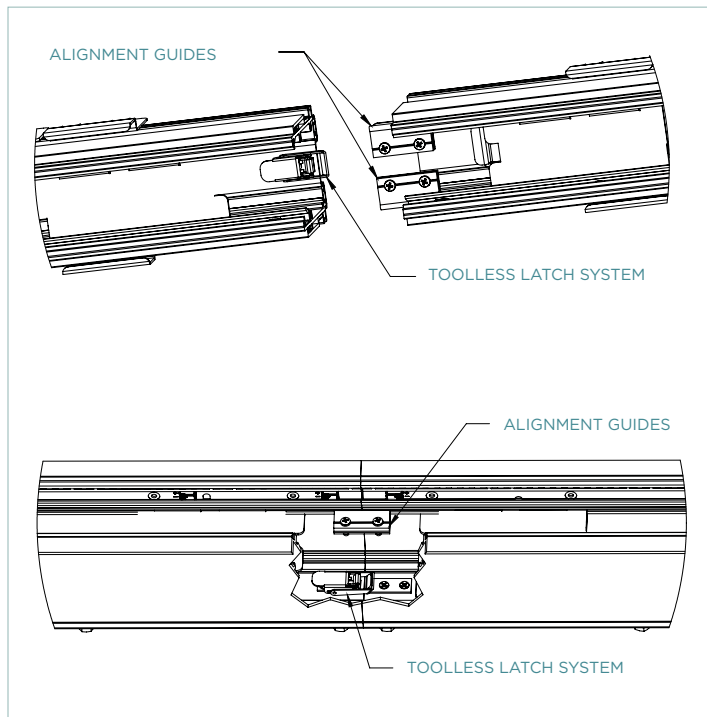

QUICK-CLICK 5-WIRE SYSTEM

Our Quick-Click 5-Wire System connects the continuous run through wiring with a simple push and click connection. The Quick-Click System is contractor friendly and decreases installation time and cost and ensures proper wiring.

