



Laguna 1 Series

LGA-1R-LP

LOUVERED RECESSED CEILING

Brilliant by Design™, minimalistic aesthetic combined with our innovative Louvered Optic solutions will bring your vision to light. The innovative Micro Optic Louver and Point Source Louver designs utilize high efficiency 90+ CRI chips and innovative louver designs for precise light management while meeting and exceeding the Well Building standard for glare.

FEATURES

- Micro Optic Louver (MOL) or Point Source Louver (PSL) delivers unparalleled optic control and exceptional performance.
- Point Source Louver 80° optic offers a deeper louver with “extra quiet” visual effect.
- Micro Optic Louver 60° offers a shallower louver with “illuminated quiet” visual effect.
- Meets or exceeds Well Building standards for glare.
- Trim Flange, Spackle Flange, 15/16” or 9/16” Grid Lay-in, 15/16” or 9/16” Grid Tegular, Bolt Slot or Armstrong Interlude/USG Identitee.
- Minimalistic 1.5” Aperture.
- Innovative slider optic removal system allows for easy installation and serviceability.
- Individual fixture lengths and seamless continuous runs.
- Integrated Wired/Wireless Controls and Sensors and Emergency Driver options available.
- Specified Lumen Outputs (SLO) available.
- Proudly crafted in Huntington Beach, CA - USA.
- BABA approved in most configurations. Consult factory for details.



Point Source Louver (PSL) in Black. Micro Optic Louver (MOL) in White

Performance Overview

4' Laguna 1 Direct - 3500K 90CRI - PSL80-WH*				
Lumen Output	LL (Low)	ML (Medium)	HL (High)	SLO** (Specified)
Delivered Lumens	1036	2296	4444	524-7116
Consumed Wattage	6.68	15.76	33.2	3.28-59.20
Efficacy (lm/W)	155	146	134	159-120
SDCM	3	3	3	

*Calculations are based on White Louver (most efficient). See Specified Lumen Output configurator for Black and Silver.
 **Specified Lumen Output (SLO) available in customizable lumen configurations (524 lm - 6082 lm). See SLO Configurator at ExtantLighting.com



ORDERING INFORMATION

Project: _____

Date: _____ Type: _____

Product Family	Driver Location	Trim	Length	Lumen Output
LGA-1R-LP	TD			
LGA-1R-LP Huntington Series 1.5" Aperture (Recessed - LoPro)	TD Integral Driver	TRIM FLANGE- Powder Coat Finish TFSA Trim Flange - Silver Anodized TFWP Trim Flange - Matte White TFBP Trim Flange - Matte Black TFCC Trim Flange - Custom Color TRIMLESS SF Spackle Flange (Mud-in) T-GRID L1* 15/16" Grid Lay-in System L9* 9/16" Grid Lay-in System T1* 15/16" Grid Tegular System T9* 9/16" Grid Tegular System SB* Bolt Slot Grid System AI* Armstrong Interlude/USG Identitee <small>*White finish is standard on all T-Grid (Suspended Ceiling) trim options (L1, L9, T1, T9, SB and AI)</small>	___ * Specify Nominal Fixture Length R_X_ Rectangle L_X_L Pattern U_X_X_ U Pattern PC Custom Pattern <small>*Minimum Integral Driver length is 2'. *Any length over 8' requires multiple fixture segments. *Actual fixture lengths are based on 11" increments</small>	DLL* Low (259 l/ft @ 1.67 W) DML* Medium (574 l/ft @ 3.94 W) DHL* High (1111 l/ft @ 8.3 W) SLO-XX** Specified Lumen Output available. <small>*Delivered lumen output & consumed wattage based on "PSL80-WH 35" 90 CRI - 3500K (Most Efficient) See Specified Lumen Output configurator for alternative outputs and Black and Silver calculations at ExtantLighting.com **See SLO Configurator at ExtantLighting.com for appropriate "xx" output.</small>

Louver Optic/Color	Color Temp	Voltage	Driver	Finish
PSL: Point Source Louver PSL80-BK 80° Black Louver PSL80-WH 80° White Louver PSL80-SL 80° Silver Louver MOL: Micro Optic Louver MOL60-BK 60° Black Louver MOL60-WH 60° White Louver	27 2700K 30 3000K 35 3500K 40 4000K 50 5000K XX Optional Color Temp & CRI Available	VU 120V-277V V3 347V	D* 1% 0-10V DN NON DIM DL1 Lutron Hi-Lume 1% EcoSystem DE 1% 0-10V DD1 1% DALI DDE 1% DALI DMX 1% DMX/RDM DELV 1% Electronic Low Voltage Dimming (Reverse Phase dimming) DTRIAC 1% Electronic Low Voltage Dimming (Forward Phase dimming) XX Other (Please Specify) <small>*Dim to Off available. Please Specify "-OFF" next to driver option if required.</small>	EMC_* Emergency Circuit(s) EMB_* Emergency Battery Pack(s) SOC* Occupancy Sensor SDL* Daylight Sensor BCS* Brilliant Communications Solutions (wired/wireless) MTC* Multiple Circuit(s) (Daylight, Occupancy, Zone Specific) JAB JAB Compliant CP Chicago Plenum Approved <small>*EMC: Specify quantity of emergency circuits. *EMB: Specify quantity of battery packs. Minimum 4' unit. *SOC & SDL: Specify spacing/location of sensor(s). *BCS: includes wired and wireless integration from our partners at nLight™, enlightened, Legrand, Crestron, Osram, Lutron and many more. *MTC: Circuit location(s) to be identified through factory supplied drawings</small>



Specifications

CONSTRUCTION One-piece heavy gauge 6063 extruded aluminum housing.

OPTICS Specify Point Source Louver (PSL) Optics or Micro Optic Louver (MOL)

- Point Source Louver 80° optic offers a deeper louver with “extra quiet” visual effect
- Micro Optic Louver 60° offers a shallower louver with “illuminated quiet” visual effect.

LIGHT OUTPUT (3) Standard lumen packages are available: Low (DLL), Medium (DML) and High (DHL). Specified Lumen Output (SLO) packages available. Please see the (SLO) configurator at ExtantLighting.com.

LEDS Latest generation of premium 3-step MacAdam Ellipse LED’s available in (90+ CRI) 2700K, 3000K, 3500K, 4000K. LED modules are easily accessible and replaceable.

VOLTAGE Universal 120/277V (VU) and 347V (V3) available. Consult factory for driver options when 347V is specified.

EMERGENCY BATTERY Factory provided low profile 6.5W emergency battery for UL924 required 90-minute run time (optional).

FINISH Standard finishes include powder coated silver anodized, powder coated white or powder coated black. White powder coat finish standard on all T-Grid trim options. Custom colors available.

CONTINUOUS ROWS Innovative slider optic removal system allows for easy installation and serviceability. Individual fixture lengths and seamless continuous runs.

PATTERNS Standard Rectangle Pattern (R), U Pattern (U), and L Pattern (L) available. Custom patterns available.

MOUNTING Trim Flange, Spackle Flange, 15/16” or 9/16” Grid Lay-in, 15/16” or 9/16” Grid Tegular, Bolt Slot or Armstrong Interlude/USG Identitee.

APPROVALS UL and cUL Listed. Approved for Dry/Damp locations. Made in the USA. JA8 Approved. BABA approved for most configurations.

LUMEN MAINTENANCE (L70) 70% of initial light output = Reported > 60,000 hours | Calculated > 200,000 hours (L90) 90% of initial light output = Reported > 60,000 hours | Calculated > 200,000 hours.

WARRANTY LGA 1 offered with a 5-year limited warranty. 5-year limited warranty covers LED, driver and fixture. For further details, refer to General Warranty and Obligations at ExtantLighting.com.

Dimensions

TF - TRIM FLANGE

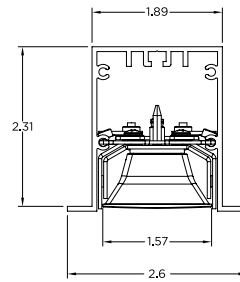

SF - SPACKLE FLANGE

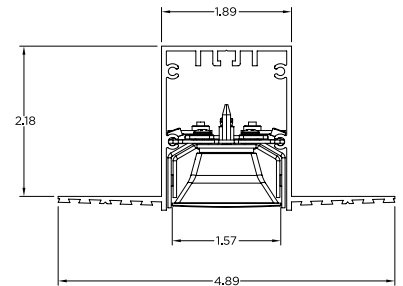

L1 - 15/16” GRID LAY-IN

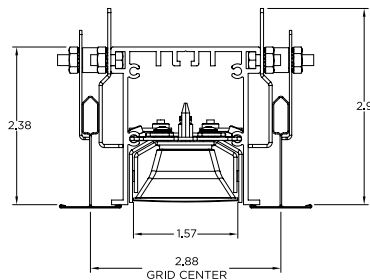

L9 - 9/16” GRID LAY-IN

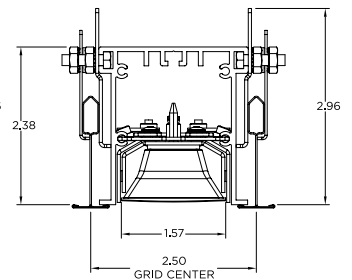

T1 - 15/16” GRID TEGULAR

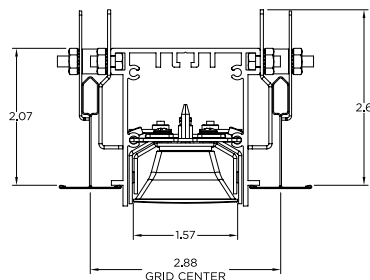

T9 - 9/16” GRID TEGULAR

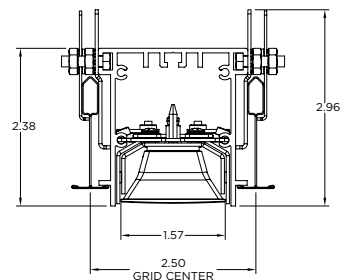

SB - BOLT SLOT GRID

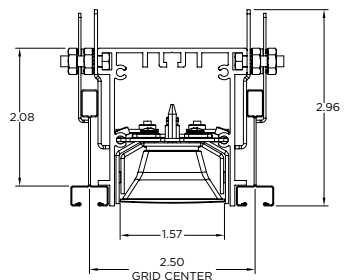

AI - ARMSTRONG INTERLUDE/
USG IDENTITEE

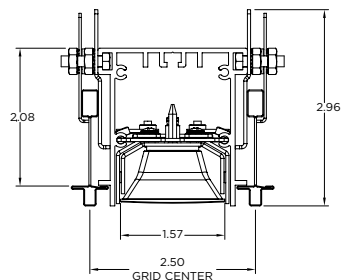

Micro Optic Louver (MOL) and Point Source Louver (PSL)

The Micro Optic Louver (MOL) and Point Source Louver (PSL) designs integrate highly efficient 90+ CRI chips with cutting-edge louver technology for superior light management. These solutions deliver exceptional performance and enhanced visual comfort by minimizing glare and optimizing light distribution. Both designs are engineered to meet and exceed the Well Building standard for glare reduction.

MICRO OPTIC LOUVER (MOL) 60°:

Features a shallower louver for an “illuminated quiet” visual effect, offering precise optic control.

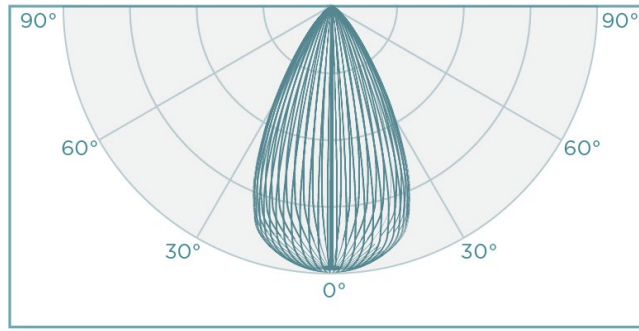

POINT SOURCE LOUVER (PSL) 80°:

Provides a deeper louver with an “extra quiet” visual effect, also focusing on excellent optic control.

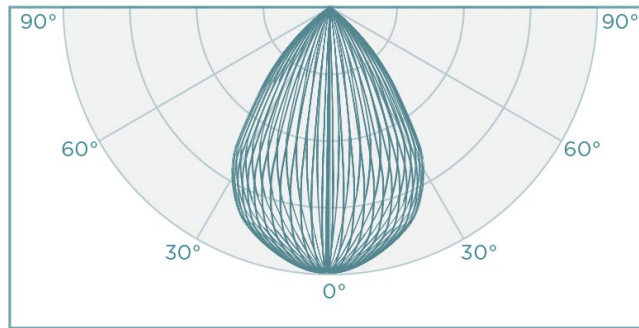

Installation

Thoughtful engineering is at the core of all of our fixture designs. All of our products are thoughtfully engineered and include innovative features that create a sophisticated fixture that is also contractor friendly and easy to install and service.

TOOLLESS LATCH SYSTEM

Our Toolless Latch System is designed to securely connect the extrusions of the continuous runs without the use of any tools, screws or external parts. Our innovative design allows the contractor to perfectly align the extrusion with the built-in alignment pins and cinch up the extrusion with the Toolless Latch System for a tight fit. The Toolless Latch System eliminates gaps and ensures perfect alignment.

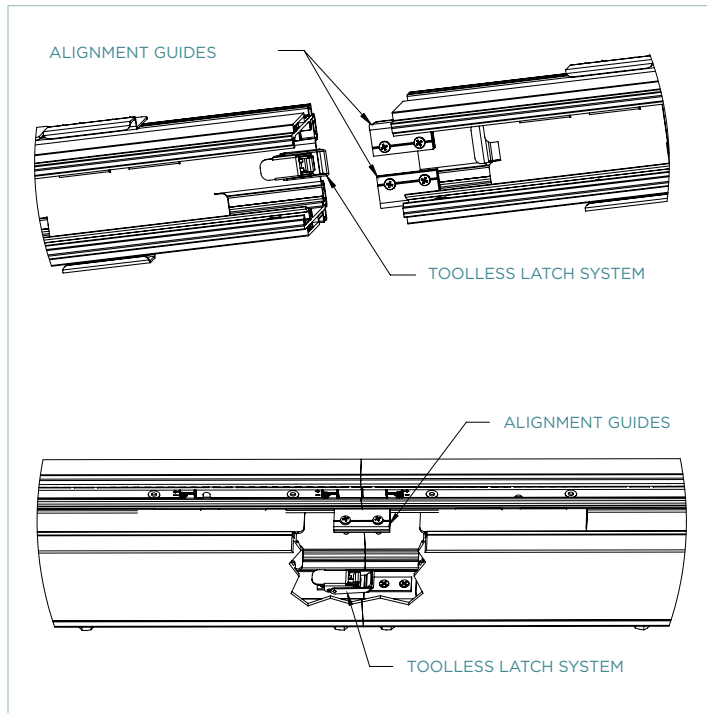

QUICK-CLICK 5-WIRE SYSTEM

Our Quick-Click 5-Wire System connects the continuous run through wiring with a simple push and click connection. The Quick-Click System is contractor friendly and decreases installation time and cost and ensures proper wiring.

