



Huntington 3 Series

HTG-3

SURFACE T-GRID

Brilliant by Design™, minimalistic aesthetic combined with our innovative Microstructure EdgeTech Optics (MEO)™ will bring your vision to light. The innovative MEO™ design utilizes high efficiency Microstructure Lenses and Light Guide Plates for high optical extraction and precise light management.

FEATURES

- Mounts directly to the T-Grid for seamless performance and integration.
- Specify Batwing, Glare Control, Diffused (Lambertian) optics or Wall Wash Optics.
- MEO™ allows for minimalistic 3" Aperture fixture while only being 1.38" deep.
- High performance with visual comfort (224-1713 lm/ft).
- Individual fixture lengths and seamless continuous rows with no lens breaks, pixelation or hotspots up to 300 feet.
- Mitered lit corner patterns.
- Innovative Toolless "Push to Eject" System allows for easy installation and serviceability.
- Innovative T-Grid mounting mechanism for flush T-Grid surface mounting.
- 16' on center spacing with MEOBW (Batwing).
- Custom powder coat and anodized finishes.
- Specified Lumen Outputs (SLO) available.
- Proudly crafted in Huntington Beach, CA - USA.

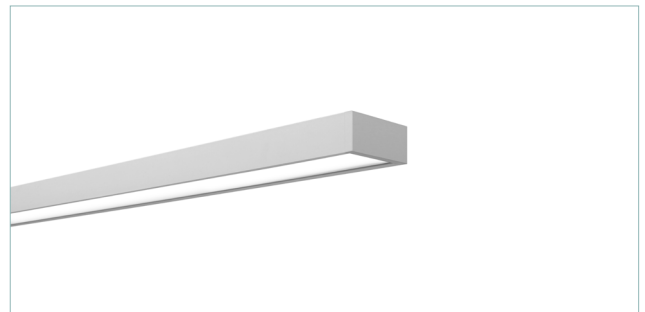

SURFACE T-GRID

Performance Overview

4' Huntington 3 Direct - 3500K 90CRI MEODF				
Lumen Output	LL (Low)	ML (Medium)	HL (High)	SLO* (Specified)
Delivered Lumens	896	2208	4352	896-6852
Consumed Wattage	7	18	38	7.3 - 65.6
Efficacy (lm/W)	122	121	115	105-122
SDCM	3	3	3	3

*Specified Lumen Output (SLO) available in customizable lumen configurations (896 lm - 6852 lm). See SLO Configurator [HERE](#)



ORDERING INFORMATION

Project: _____

Date: _____ Type: _____

Product Family	Driver Location	Driver Location	Surface T-Grid Mounting	Length	Lumen Output	Optics
HTG-3	RD					
HTG-3 Huntington Series 3" Aperture (Surface)	RD Remote Driver	Remote drivers can power multiple segments up to 12'; <u>Quantity of drivers must be selected</u> ; reference Single Driver Lumen Output Chart below to determine the quantity of drivers required.	L1 15/16" Grid Lay-in System L9 9/16" Grid Lay-in System T1 15/16" Grid Tegular System T9 9/16" Grid Tegular System SB Bolt Slot Grid AI Armstrong Interlude/USG Identitee CM* Custom Mounting	___* Specify length in 1 foot increments R_X_ Rectangle L_X_ L Pattern U_X_X_ U Pattern PC Custom Pattern	DLL Low (224 l/ft @ 1.84 W)* DML Medium (552 l/ft @ 4.55 W)* DHL High (1088 l/ft @ 9.46 W)* SLO-XX Specified Lumen Output available.**	MEQ MEODF Diffusing MEOBW Batwing MEOGC Glare Control MEOWW Wall Wash (33° off Nadir)
	*Remote drivers can power multiple segments up to 12'; reference Single Driver Lumen Output Chart below.		*Contact factory for custom orders.	*Consult factory for lengths shorter than 2'. Custom length fixtures can be ordered in 3" increments. *Any length over 8' requires multiple fixture segments.	*Delivered lumen output & consumed wattage based on "MEODF 35" (90 CRI - 3500K). See SLO Configurator for alternate outputs. **See SLO Configurator at ExtantLighting.com for appropriate "XX" output.	

Color Temp	Voltage	Driver	Finish	Options
27 2700K 30 3000K 35 3500K 40 4000K 50 5000K TW 2700K-6500K (85+ CRI) XX Optional Color Temp & CRI Available	VU 120V-277V V3 347V	D* 1% 0-10V DN NON DIM DELV 1% Electronic Low Voltage Dimming (Reverse Phase dimming) DTRIAC 1% Electronic Low Voltage Dimming (Forward Phase dimming) DL1 Lutron Hi-Lume 1% EcoSystem DE .1% 0-10V DD1 1% DALI DDE .1% DALI DMX 1% DMX/RDM DTW .1% 0-10V Tunable White DDTW .1% DALI Tunable White XX Other (Please Specify)	SA* Silver Anodized WP* Matte White BP* Matte Black CC** Custom SAMF SA Housing/Machine Finish End Caps WPMF WP Housing/Machine Finish End Caps BPMF BP Housing/Machine Finish End Caps CCMF CC Housing/Machine Finish End Caps	EMC_* Emergency Circuit(s) EMB_* Emergency Battery Pack(s) SOC* Occupancy Sensor SDL* Daylight Sensor BCS* Brilliant Communications Solutions (wired/wireless) CP Chicago Plenum Approved JAB JAB Compliant
		*Dim to Off available. Please Specify "-OFF" next to driver option if required.	*The housing finish and end cap finish will match. ** Custom Color (CC) to be provided in satin finish and color to be specified by a RAL number. The housing finish and end cap finish will match.	*EMC: Specify quantity of emergency circuits. *EMB: Specify quantity of battery packs. Minimum 4' unit. *SOC & SDL: Specify spacing/location of sensor(s). *BCS: includes wired and wireless integration from our partners at nLight™, enlightened, Legrand, Crestron, Osram, Lutron and many more.

Single Driver Lumen Output Chart
Note: Remote drivers can power multiple segments up to 12'

Segment Length	Lumen Output Options
1	DLL, DML, DHL
2	DLL, DML, DHL
3	DLL, DML, DHL
4	DLL, DML, DHL
5	DLL, DML, DHL
6	DLL, DML, DHL
7	DLL, DML, DHL
8	DLL, DML, DHL
9	DLL, DML
10	DLL, DML
11	DLL, DML
12	DLL, DML



Specifications

CONSTRUCTION One-piece heavy gauge 6063 extruded aluminum housing. Precision-machined aluminum end caps.

OPTICS Microstructure EdgeTech Optics (MEO)™ utilizes high efficiency Microstructure Lenses and Light Guide Plates for high optical extraction and precise light management. Specify Batwing, Glare Control, Diffused (Lambertian), or Wall Wash Optics.

LIGHT OUTPUT (3) Standard lumen packages are available: Low (DLL), Medium (DML) and High (DHL). Specified Lumen Output (SLO) packages available. Please see the (SLO) configurator at ExtantLighting.com.

LEDS Latest generation of premium Nichia 3-step MacAdam Ellipse LED's available in (90+ CRI) 2700K, 3000K, 3500K, 4000K. LED modules are easily accessible and replaceable.

VOLTAGE Universal 120/277V (VU) and 347V (V3) available. Consult factory for driver options when 347V is specified.

EMERGENCY BATTERY Factory provided low profile 10W emergency battery for UL924 required 90-minute run time (optional).

FINISH Standard finishes include silver anodized, powder coated white or powder coated black. Custom anodized and powder coated finishes available (RAL number matched). Power cord and canopy finish options are white, black or silver.

CONTINUOUS ROWS Innovative Toolless Latch System ensures simple installation. Seamless continuous rows with no lens breaks, pixelation or hotspots up to 300 feet with MEODF or 250 feet with MEOGC.

PATTERNS Standard Rectangle Pattern (R), U Pattern (U), and L Pattern (L) available. Custom patterns available.

MOUNTING T-Grid Surface Mount

APPROVALS UL and cUL Listed. Approved for Dry/Damp locations. Made in the USA. JA8 Approved.

LUMEN MAINTENANCE (L70) 70% of initial light output = Reported > 60,000 hours | Calculated > 200,000 hours (L90) 90% of initial light output = Reported > 60,000 hours | Calculated > 200,000 hours.

WARRANTY HTG 3 offered with a 5-year limited warranty. 5-year limited warranty covers LED, Driver and fixture. For further details, refer to General Warranty and Obligations at ExtantLighting.com.

PATENTS Extant Lighting's intellectual property is protected under Patent No. US 11,378,262 B2 by the U.S. Patent Office.

T-GRID MOUNTING DETAIL

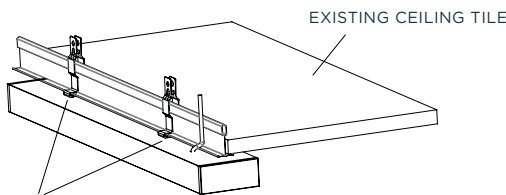

INNOVATIVE T-GRID MOUNTING HARDWARE EASILY INTEGRATES AND ATTACHES TO EXISTING T-GRID WITH FIELD OPTION FOR HANGER BAR MOUNTING

OFFSET WIRE MANAGEMENT SYSTEM ALLOWS FOR SIMPLE INSTALLATION WITHOUT DRILLING THROUGH T-GRID

Microstructure EdgeTech Optics (MEO)™

Our innovative MEO™ design utilizes high efficiency Microstructure Lenses and Light Guide Plates for high optical extraction and precise light management. MEO™ delivers exceptional light quality with seamless illumination and uniformity with no pixelation, hot spots or lens breaks up to 300' continuous rows.

DIRECT

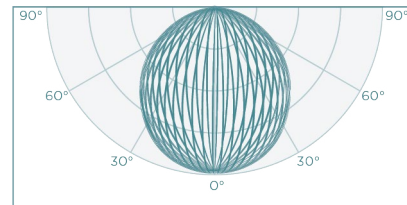

MEODF
LAMBERTIAN

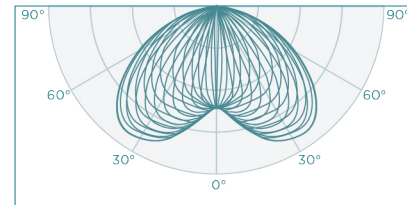

MEOBW
BATWING

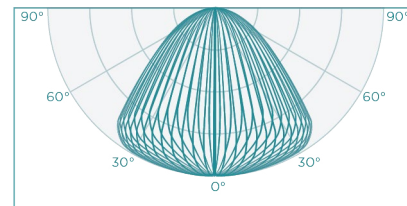

MEOGC
GLARE CONTROL

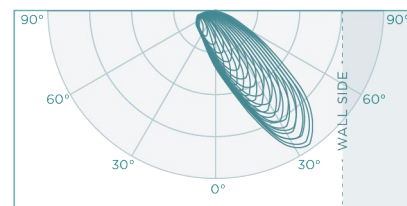

MEOWW
WALL WASH
33° OFF NADIR



Dimensions

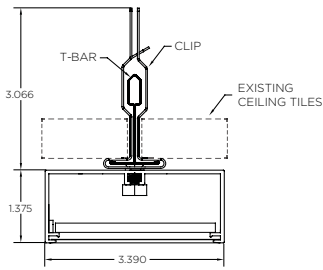

L1 - 15/16" Grid Lay-in

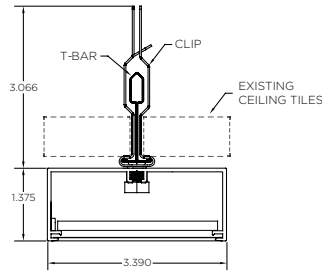

L9 - 9/16" Grid Lay-in

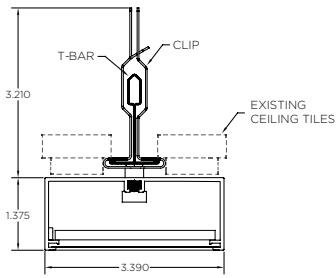

T1 - 15/16" Grid Tegular

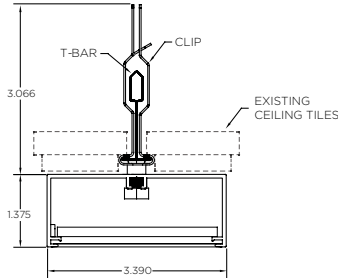

T9 - 9/16" Grid Tegular

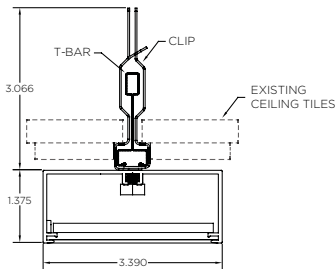

SB - Bolt Slot Grid

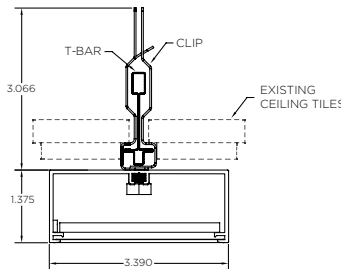

**AI - Armstrong Interlude/
USG Identitee**

Patterns

Note: All miters/patterns shown and ordered in plan view.

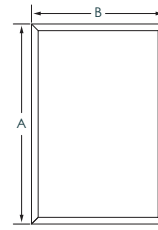

R__X__
Rectangle
Provide AxB
Example: R6'x4'

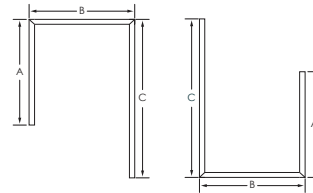

U__X__X__
U-Shape
Provide AxBxC
Example: B U6'x4'x4'

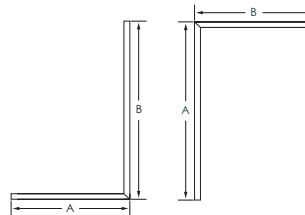

L__X__
L-Shape
Provide AxB
Example: L6'x4'



Continuous Row Detail

NOTE: Detail below is specific to the Surface unit only. For additional Continuous Row Detail, please visit ExtantLighting.com

Nominal Row Length (ft)	Segment Lengths (ft)	Overall Row Length
9	5 + 4	9' 1/2"
10	6 + 4	10' 1/2"
11	7 + 4	11' 1/2"
12	8 + 4	12' 1/2"
13	8 + 5	13' 1/2"
14	8 + 6	14' 1/2"
15	8 + 7	15' 1/2"
16	8 + 8	16' 1/2"
17	8 + 5 + 4	17' 1/2"
18	8 + 6 + 4	18' 1/2"
19	8 + 7 + 4	19' 1/2"
20	8 + 8 + 4	20' 1/2"
21	8 + 8 + 5	21' 1/2"
22	8 + 8 + 6	22' 1/2"
23	8 + 8 + 7	23' 1/2"
24	8 + 8 + 8	24' 1/2"
25	8 + 8 + 5 + 4	25' 1/2"
26	8 + 8 + 6 + 4	26' 1/2"
27	8 + 8 + 7 + 4	27' 1/2"
28	8 + 8 + 8 + 4	28' 1/2"
29	8 + 8 + 8 + 5	29' 1/2"
30	8 + 8 + 8 + 6	30' 1/2"
31	8 + 8 + 8 + 7	31' 1/2"
32	8 + 8 + 8 + 8	32' 1/2"
33	8 + 8 + 8 + 5 + 4	33' 1/2"
34	8 + 8 + 8 + 6 + 4	34' 1/2"
35	8 + 8 + 8 + 7 + 4	35' 1/2"
36	8 + 8 + 8 + 8 + 4	36' 1/2"
37	8 + 8 + 8 + 8 + 5	37' 1/2"
38	8 + 8 + 8 + 8 + 6	38' 1/2"
39	8 + 8 + 8 + 8 + 7	39' 1/2"
40	8 + 8 + 8 + 8 + 8	40' 1/2"
41	8 + 8 + 8 + 8 + 5 + 4	41' 1/2"
42	8 + 8 + 8 + 8 + 6 + 4	42' 1/2"
43	8 + 8 + 8 + 8 + 7 + 4	43' 1/2"
44	8 + 8 + 8 + 8 + 8 + 4	44' 1/2"
45	8 + 8 + 8 + 8 + 8 + 5	45' 1/2"
46	8 + 8 + 8 + 8 + 8 + 6	46' 1/2"
47	8 + 8 + 8 + 8 + 8 + 7	47' 1/2"
48	8 + 8 + 8 + 8 + 8 + 8	48' 1/2"



Installation

Thoughtful engineering is at the core of all of our fixture designs. All of our products are thoughtfully engineered and include innovative features that create a sophisticated fixture that is also contractor friendly and easy to install and service.

PUSH TO EJECT SYSTEM

Innovative “Push to Eject” System allows for toolless removal and installation of the Light Guide Plate. This thoughtful engineering creates easy access into the housing for simple installation and serviceability.

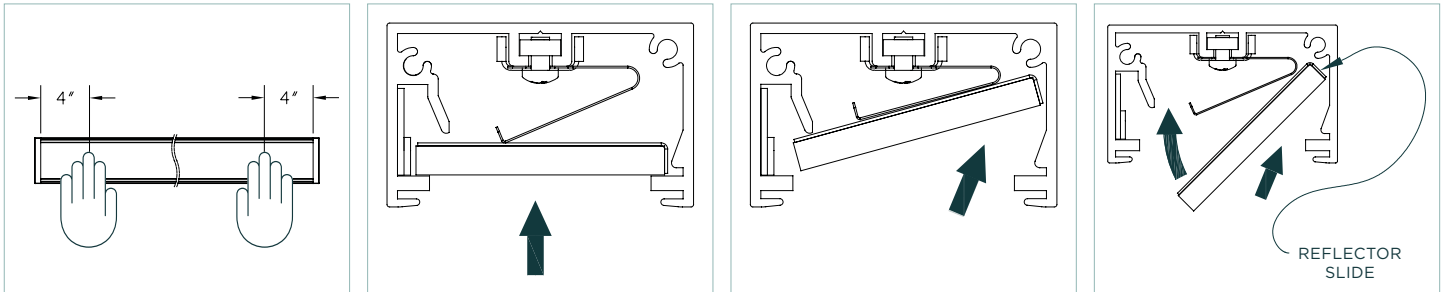

TOOLESS LATCH SYSTEM

Our Toolless Latch System is designed to securely connect the extrusions of the continuous runs without the use of any tools, screws or external parts. Our innovative design allows the contractor to perfectly align the extrusion with the built-in alignment pins and cinch up the extrusion with the Toolless Latch System for a tight fit. The Toolless Latch System eliminates gaps and ensures perfect alignment.

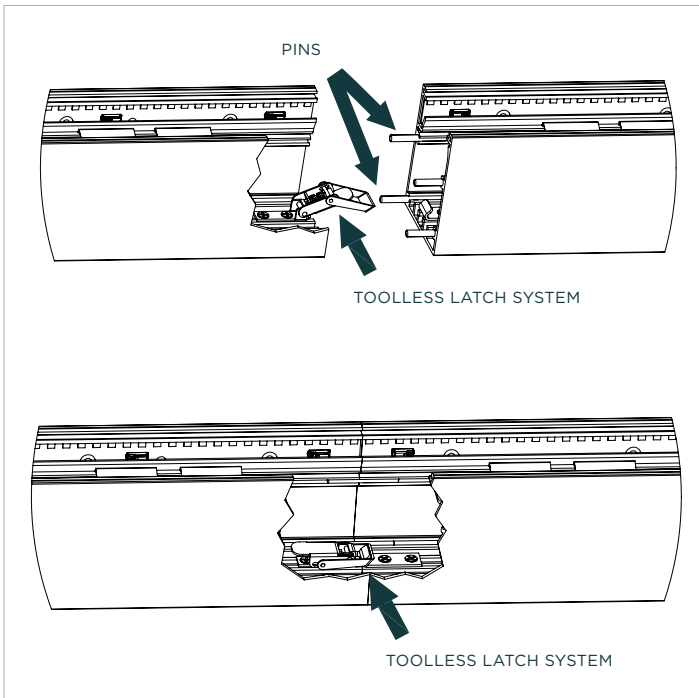

QUICK-CLICK 5-WIRE SYSTEM

Our Quick-Click 5-Wire System connects the continuous run through wiring with a simple push and click connection. The Quick-Click System is contractor friendly and decreases installation time and cost and ensures proper wiring.

